



## D2 DIAMOND MOUNT

### DESCRIPTION

- Designed for most stick framed roof types
- Accepts 3/4" X 3/4" square fence pipe
- Installed using (4) 3/8" Lag bolts
- Must be installed into structural roof member such as a truss or rafter beam
- All roof penetrations that go through the underlayment are required to be flashed or sealed
- Ice Flags as option
- Powder coated to match roofing material color
- Overall dimensions: 4.526"L X 2"W X 4.732"H

### MATERIALS

- Steel: 3/16" (ASTM A1011 & ASTM A880)
- Copper: 1/4" (ASTM B152)
- Cor-Ten®: 3/16" (ASTM A588)

### COLORS/FINISHES

- Raw steel
- Electro-galvanized steel
- Hot-dipped galvanized steel
- Mill finish Copper
- Mill finish Cor-Ten®
- Powder coating available in many colors visit <http://trasnowandsun.com/color-chart/> to see color chart

**NOTE:** Due to specific job conditions, TRA Snow and Sun will only warranty a snow retention system/layout that has been designed by TRA Snow and Sun.

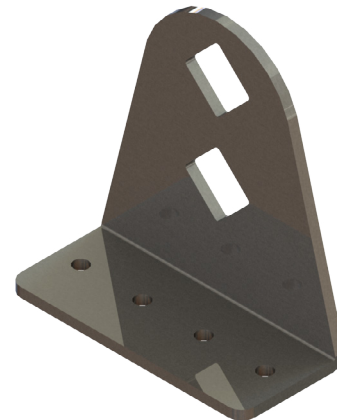

### 2 PIPE SNOW FENCE SYSTEM

**USED ON: ASPHALT SHINGLES, CEDAR SHINGLES, FLAT SEAM METAL, GRANULE METAL, METAL PANEL, SLATE, SIMULATE SLATE, TILE ROOFS, & WOOD SHAKES**

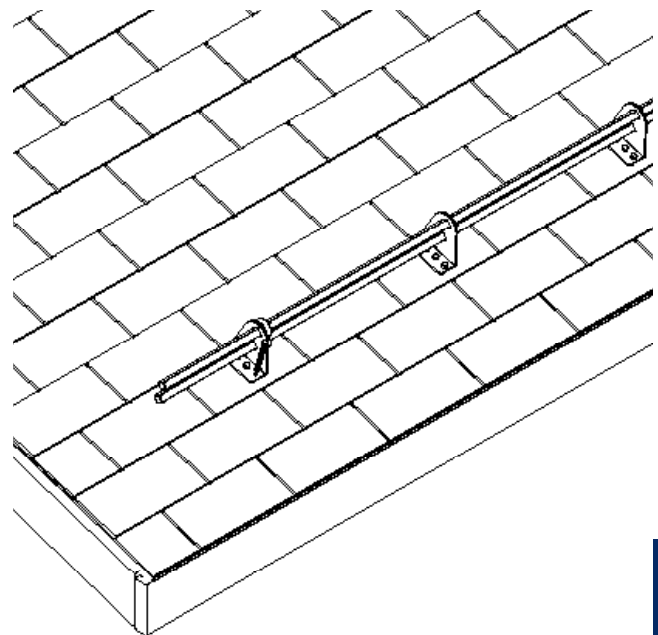
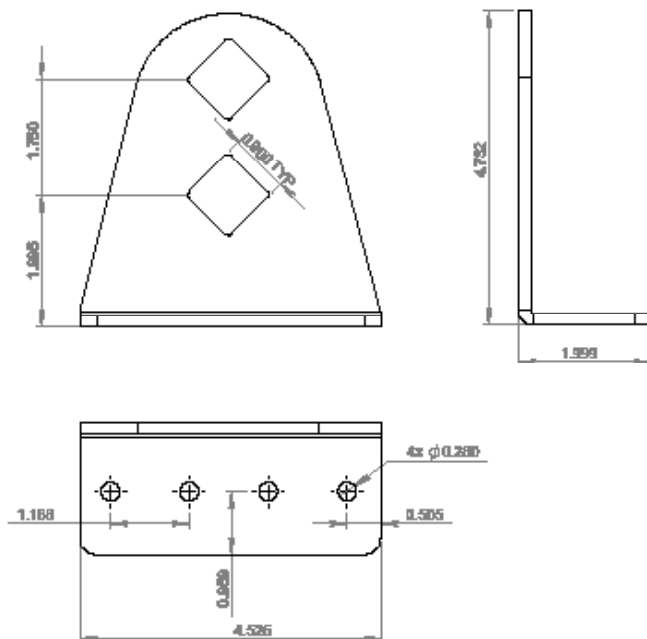

\* ALL ROOF PENETRATIONS THAT GO THROUGH THE UNDERLAYMENT ARE REQUIRED TO BE FLASHED OR SEALED.

**INSTALLATION**  
DO NOT SCALE